

# Introduction to Odor Control



Tom Ferrero

Elkhart Environmental Processing Corp

- Overview

- Why Odor Control?

- Available Techniques

- Biofilter Construction

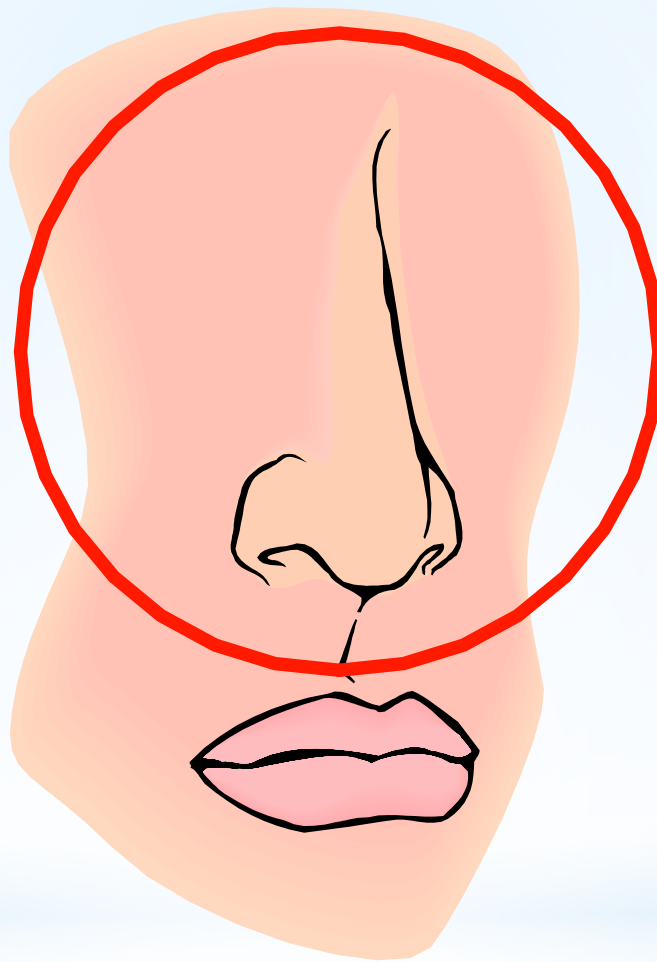

The Nose





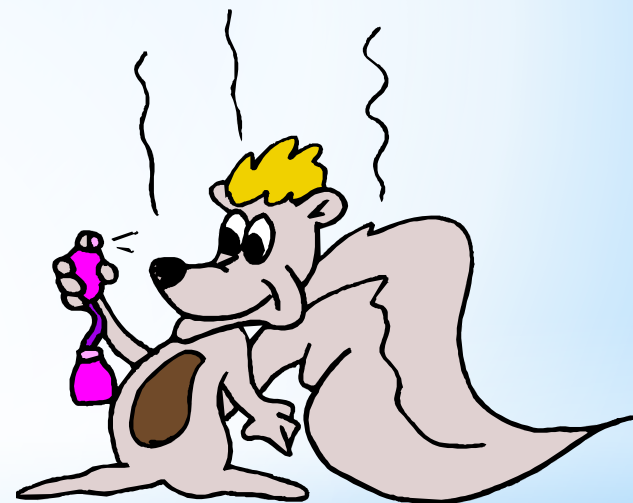

- Safety
  - Corrosion
    - Hydrogen Sulfide
  - Explosion
    - Methane
  - Health
    - Air borne disease

- Odor Control Strategy
  - Identify Sources of Odors
    - Septage Receiving Area
    - Screening and Grit Removal
    - Equalization Tanks
    - Processing – Dewatering
    - Filtrate
  - Estimate Degree of Control Required based on proximity of downwind receptors
  - Evaluate Options
  - Select Appropriate Strategy
  - Design and Construct

- Odor Control Strategy

- Best Management Practices

- Use quick-disconnect fittings
    - Avoid “Free Fall” of septage
    - Provide washdown facilities for spills
    - Ventilate tanks to odor control system
    - Everything inside!





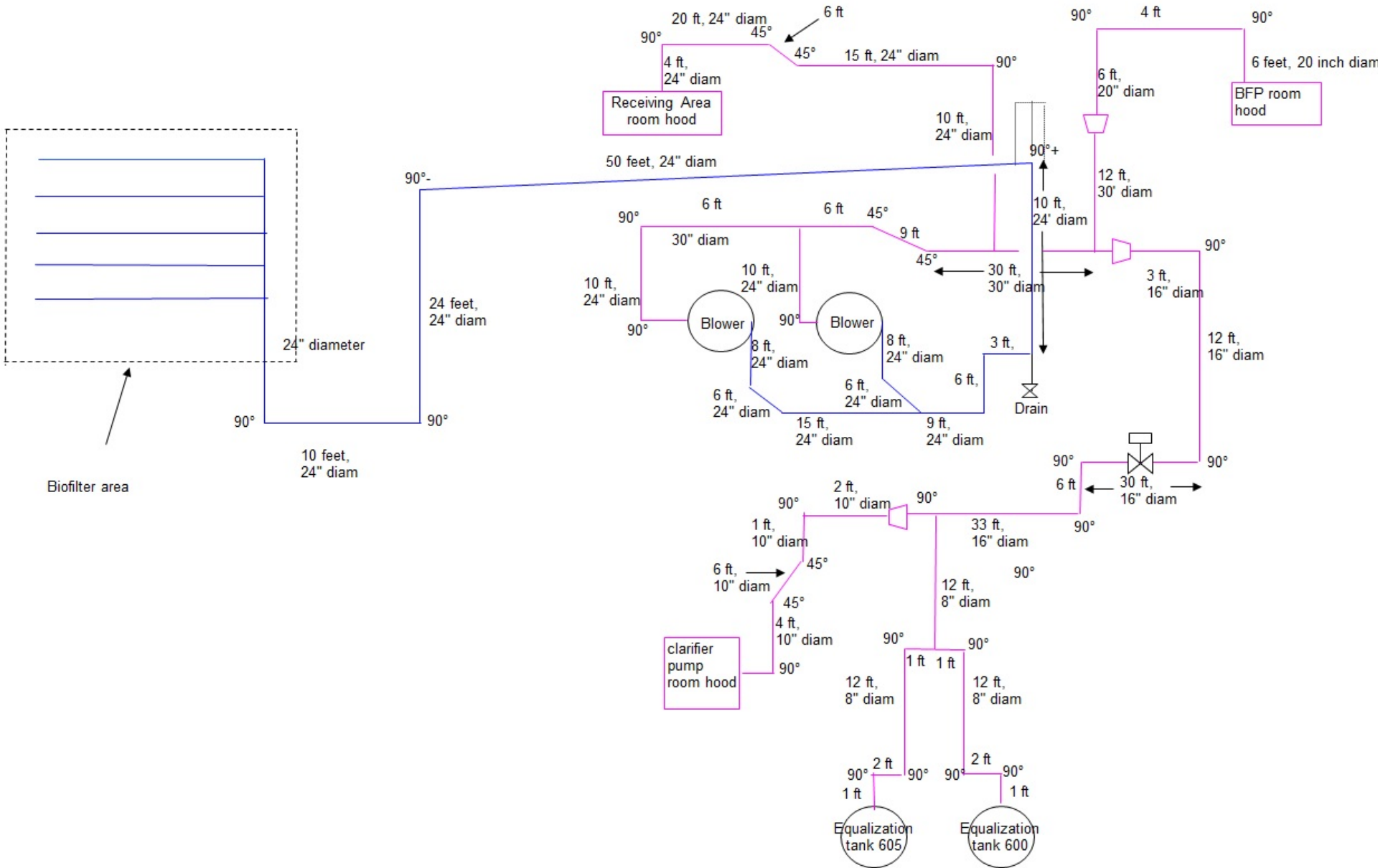

- Odor Control Strategy

- Best Management Practices





- Odor Control Strategy

- Best Management Practices



- Odor Control Strategy
  - Best Management Practices





- Odor Control Strategy
  - Best Management Practices

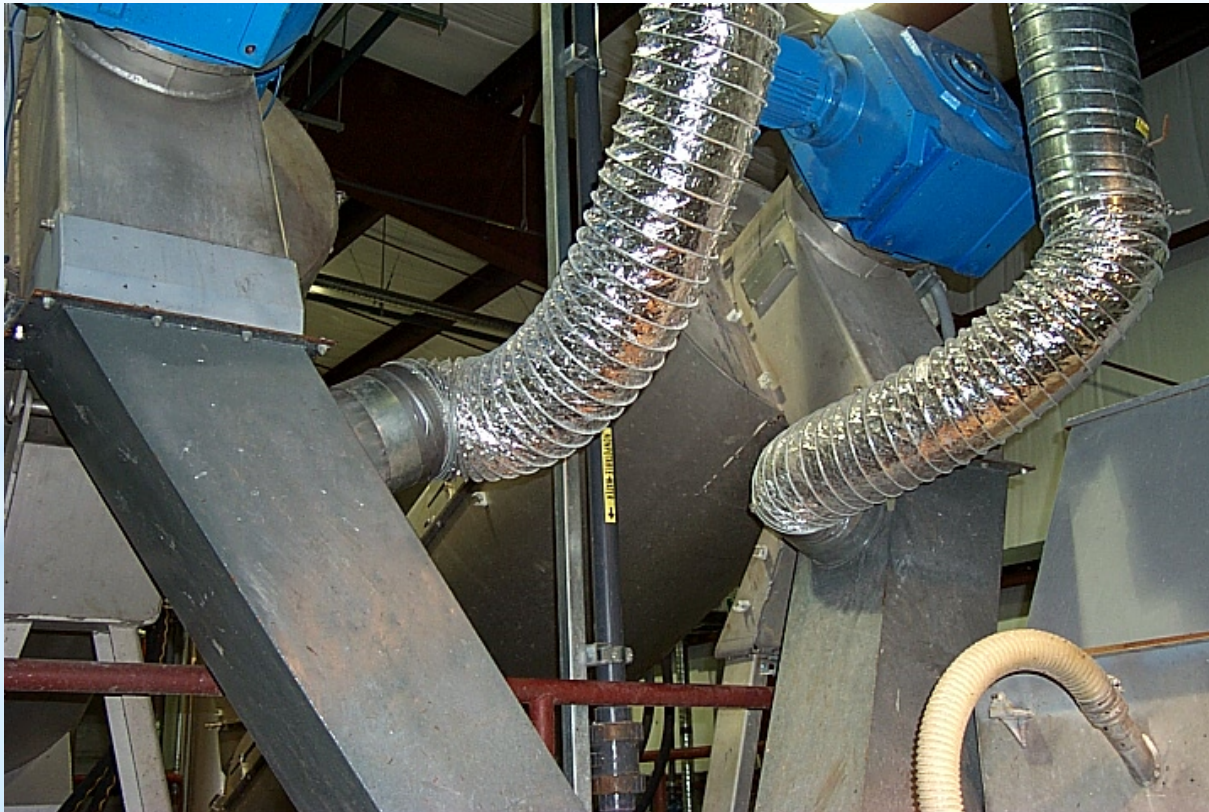

- Available Techniques

- Remote Site

- Odor counteractants (Misting)

- Wet Scrubber

- Activated Carbon

- Biofilter

- Available Techniques

- Remote Site

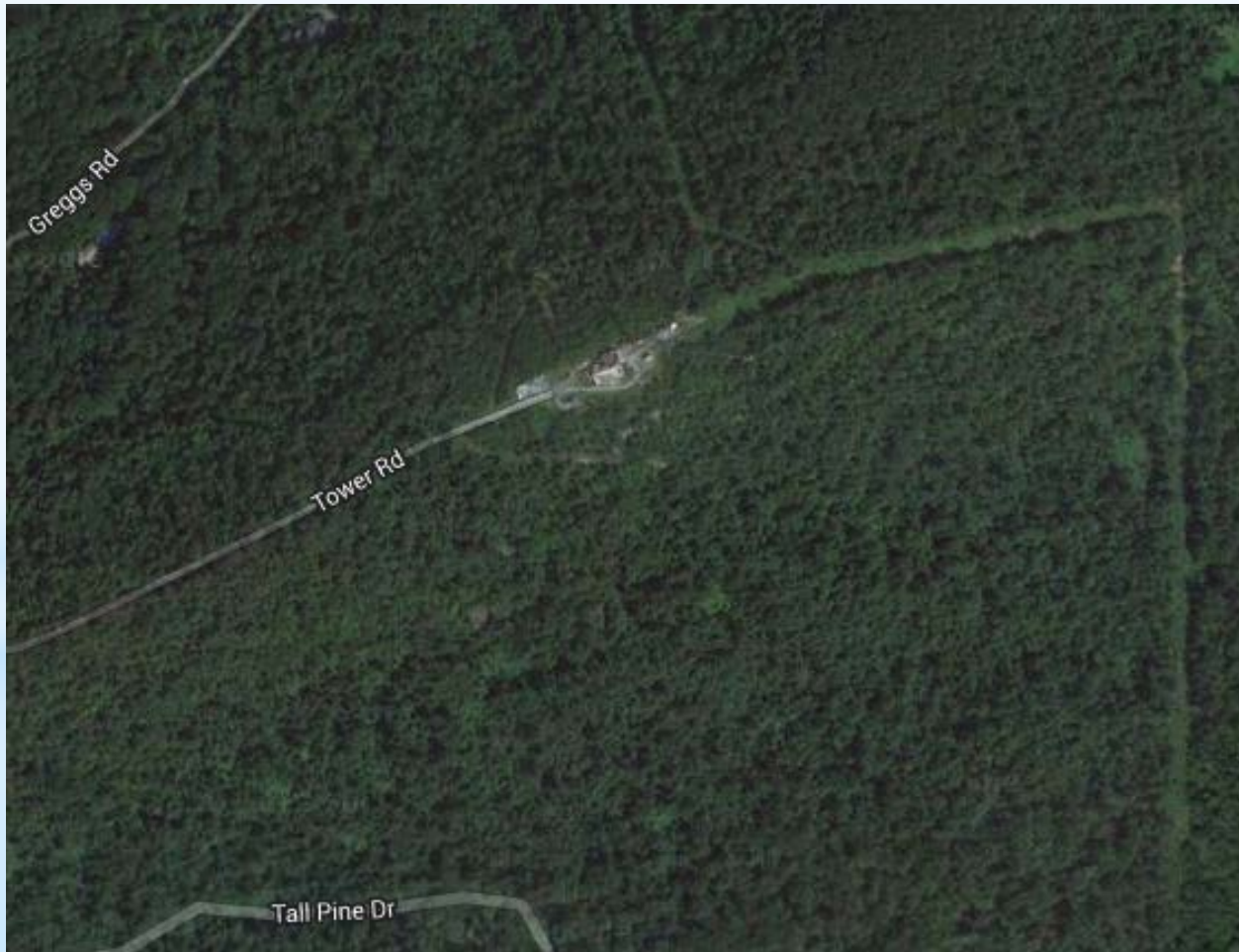



# ● Available Techniques

## ○ Misting (odor counteractants)

- Sprayed into the atmosphere
- React with odorous compounds
- Encapsulate odorous compounds
- Substantial cost of chemicals
- 30 to 40% reduction of odors

- Available Techniques
  - Odor Counteractants





- Available Techniques
  - Odor Counteractants



- Available Techniques
  - Odor Counteractants



- Available Techniques

- Wet Scrubber

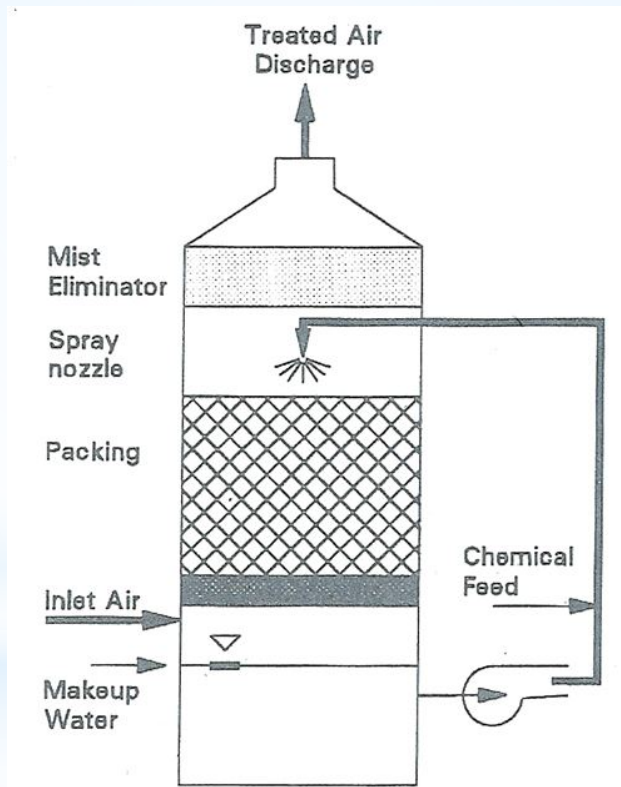

Wet Scrubber System for Odor Control



# ○ Wet Scrubber



- Available Techniques

- Activated Carbon Absorber

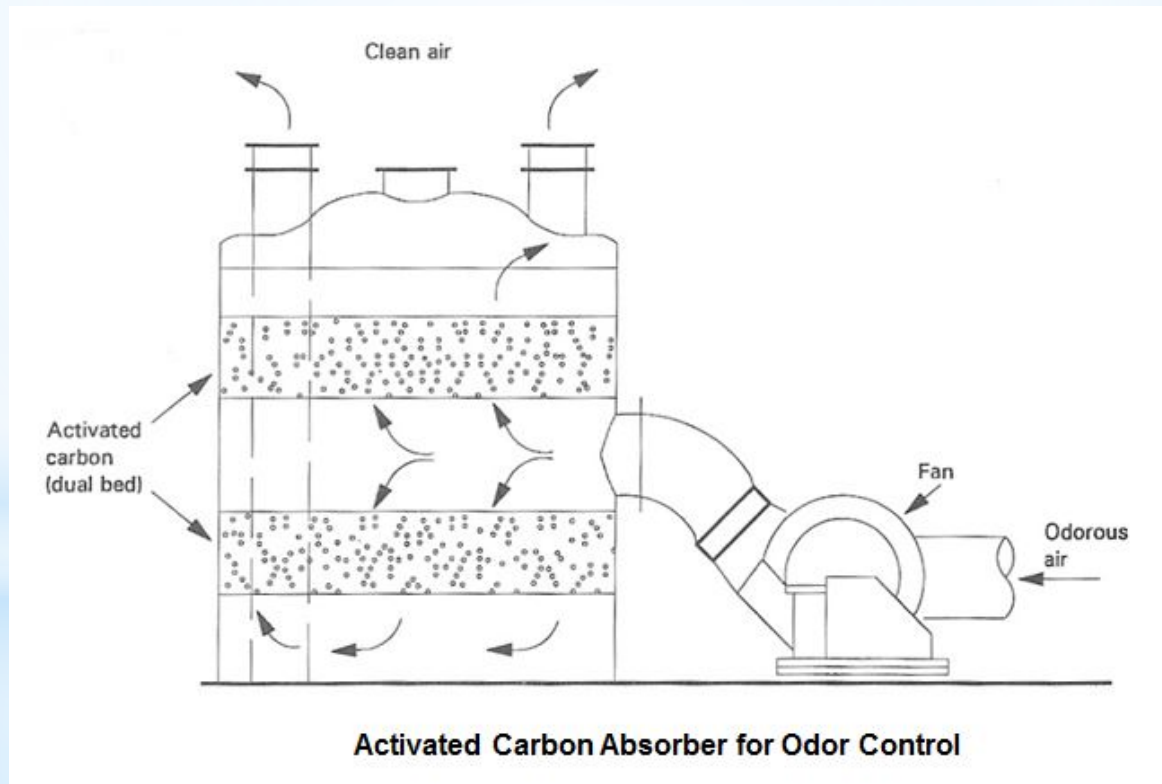



- Available Techniques

- Activated Carbon Absorber



# ● Available Techniques

## ○ Biofilters

- Passing odorous air through a media containing microbial populations
- Microbes use the odorous compounds as a food source
- Media must be kept moist and air must have good paths through media
- Requires long contact times and low velocities
- Systems come in a variety of designs and media configurations

- Available Techniques

- Biofilters



Technique	Cost Factors	Advantages	Disadvantages
Wet Scrubber	Moderate Capital and operating costs	Effective and Reliable	High Chemical Use, and spent chemical to dispose
Activated Carbon Absorber	Cost depends on frequency of carbon use	Simple, few moving parts, effective	Only applicable for dilute streams
Biofilters	Low capital and O&M costs	Simple, minimum O&M	Design criteria not well established, large land area
Odor Counteractants	Cost dependent upon chemical usage	Low Capital cost	Limited odor removal efficiency



# ● Biofilter Construction

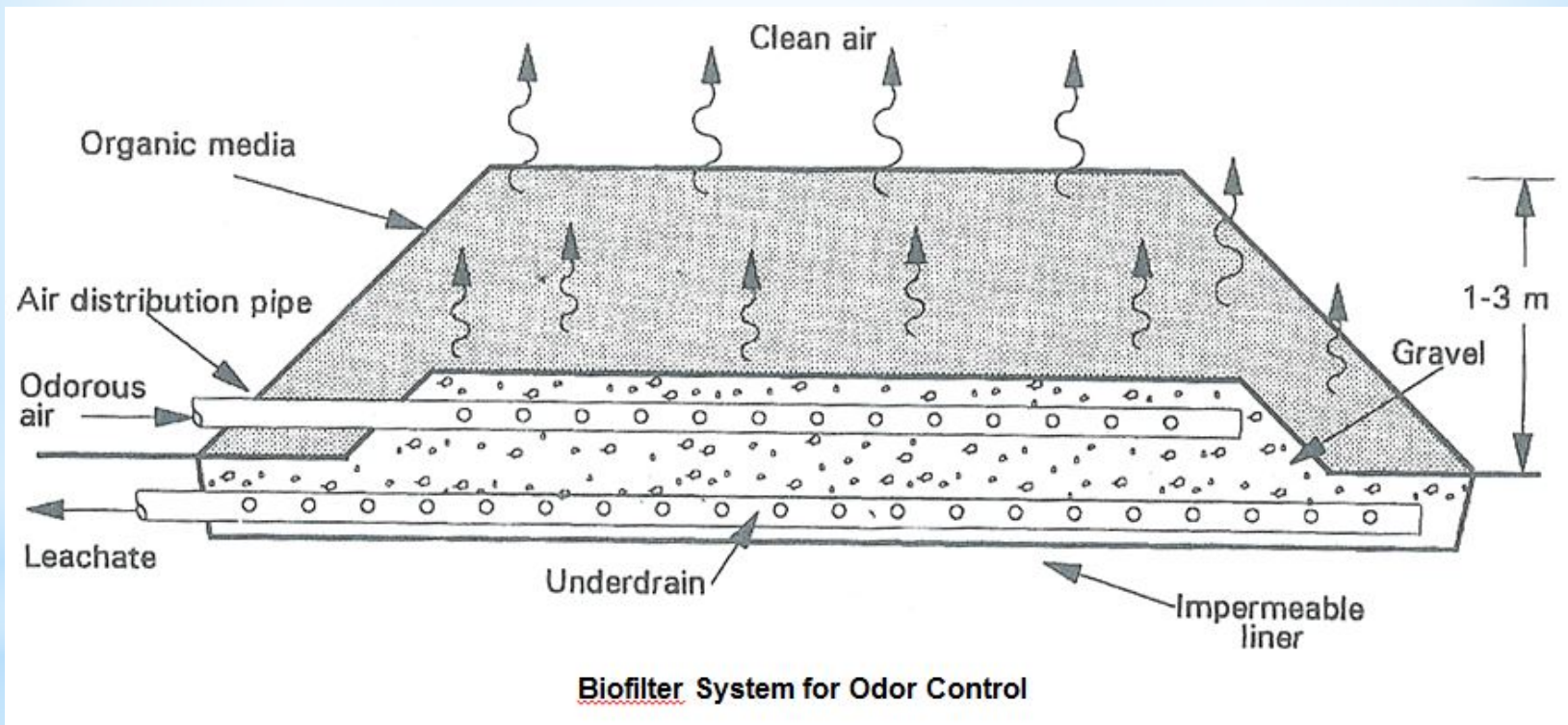



- Biofilter Construction



- Biofilter Construction



- Biofilter Construction





- Biofilter Construction





# ● Biofilter Construction





- Biofilter Construction





## Typical Design Criteria for Biofilters

Parameter	Value
Hydraulic Loading	2-10 cfm/sq ft
Detention Time	20-60 seconds
Media Depth	3-5 ft
Media pH	6-8
Pore Volume	40-50%
Moisture Content	50-60%
Media Constitutents	Bark Mulch, hardwood chips, biosolids or leaf compost
Humidity of inlet air	80-100%
Recommend air changes	6 volume changes/hour

## Typical Design Criteria for Biofilters

Parameter	Value
Hydraulic Loading	2-10 cfm/sq ft <span style="color: red;">15000 cfm / 2500 sf</span>
Detention Time	20-60 seconds
Media Depth	3-5 ft
Media pH	6-8
Pore Volume	40-50%
Moisture Content	50-60%
Media Constitutents	Bark Mulch, hardwood chips, biosolids or leaf compost
Humidity of inlet air	80-100%
Recommend air changes	6 volume changes/hour

## Typical Design Criteria for Biofilters

Parameter	Value
Hydraulic Loading	2-10 cfm/sq ft <b>6 cfm / sq ft</b>
Detention Time	20-60 seconds
Media Depth	3-5 ft
Media pH	6-8
Pore Volume	40-50%
Moisture Content	50-60%
Media Constitutents	Bark Mulch, hardwood chips, biosolids or leaf compost
Humidity of inlet air	80-100%
Recommend air changes	6 volume changes/hour



## Typical Design Criteria for Biofilters

Parameter	Value
Hydraulic Loading	2-10 cfm/sq ft <b>6 cfm / sq ft</b>
Detention Time	20-60 seconds
Media Depth	3-5 ft <b>4 ft</b>
Media pH	6-8
Pore Volume	40-50%
Moisture Content	50-60%
Media Constitutents	Bark Mulch, hardwood chips, biosolids or leaf compost
Humidity of inlet air	80-100%
Recommend air changes	6 volume changes/hour

## Typical Design Criteria for Biofilters

Parameter	Value
Hydraulic Loading	2-10 cfm/sq ft <b>6 cfm / sq ft</b>
Detention Time	20-60 seconds <b>40 seconds</b>
Media Depth	3-5 ft <b>4 ft</b>
Media pH	6-8
Pore Volume	40-50%
Moisture Content	50-60%
Media Constitutents	Bark Mulch, hardwood chips, biosolids or leaf compost
Humidity of inlet air	80-100%
Recommend air changes	6 volume changes/hour

# Introduction to Odor Control

## Questions?

Tom Ferrero

Elkhart Environmental Processing Corp

[tom@ferrero.bz](mailto:tom@ferrero.bz) (267) 250-4068